



SKYWORKS®

| CATV Solutions

Enabling Information and Entertainment with Advanced Technologies

As an innovator of high performance analog semiconductors connecting people, places and things, Skyworks' wide-ranging solutions are addressing a number of growing markets including CATV where we are enabling the delivery of high speed data channels and content to subscribers around the world.

With the pace of technology developments continually changing the way consumers receive information and entertainment, we are supporting the ever increasing demand for data requirements, combining world-class performance with industry-leading reliability. We have the most comprehensive portfolio of wide bandwidth DOCSIS 3.1 and EuroDOCSIS 3.1 compliant ultra-linear RF amplifiers.



| Table of Contents

Featured Applications 3

New and Featured Products by Applications 4

Competitor Cross Reference 5

Block Diagrams 6

Product Specifications 8

 Amplifiers 8

 Diodes 10

 Front-end Modules 10

 Mixers 11

 Splitters 11

 Switches 11

Skyworks Sales Offices 12



Scan to join our eNewsletter program today!



Featured Applications

DOCSIS 3.1, 1.2 GHz HFC

New DOCSIS 3.1 and 1218 MHz bandwidth Hybrid Fiber Coaxial (HFC) system deployments will mean higher data rates and more entertainment options than ever before for millions of users who access their content via fixed wired CATV networks. Skyworks' family of 1218 MHz CATV infrastructure amplifiers designed for these rugged and ultra-high performance applications are enabling the future of high-speed internet access by offering broader bandwidth, higher RF output power, and higher gain options.

Deep Fiber Node + 0

The best CATV HFC system architecture for achieving maximum data rates for consumers requires putting the fiber node as deep within the system as possible, minimizing service group size. The reduction in active system components after the node also offers reductions in overall power consumption and improvements in network reliability. Skyworks' family of super-high RF power output stage drivers and accompanying Push-pull intermediate stage drivers, are enabling these Deep Fiber / Node + 0 architectures with the highest efficiencies and maximum linear RF power—all at standard power supply voltages.

1 GHz HFC

Global upgrades from 550 and 870 MHz to 1000 MHz CATV HFC networks show no signs of stopping. Skyworks offers a complete suite of 12 V and 24 V CATV infrastructure amplifiers in both MMIC and Hybrid formats. These 1 GHz amplifiers are ideal for nodes, system amps, and line extenders, both as drop-in replacements for legacy devices as well as new designs where performance and cost effectiveness are key.

870 MHz HFC

Skyworks' 870 MHz CATV infrastructure amplifier products offer customers a decades-long legacy of reliability, performance, and value. Our portfolio of 12 V and 24 V amplifiers for 870 MHz CATV equipment upgrades enable cost-efficient CATV deployments.

Headend and Remote PHY

Performance demands for each channel in the CATV headend continue to increase. Skyworks' CATV infrastructure amplifiers targeting headend applications have stayed ahead of demanding linearity, bandwidth, and power requirements. Our 1218 MHz headend amplifiers include both fixed and variable gain options enabling the latest in headend systems, as well as future Remote PHY systems.

FTTx

Fiber to the home, curb, and premises—plus standard optical receiver modules for CATV fiber nodes—all require highly linear broadband RF amplifiers to enable the conversion from optical to RF. Skyworks' optical receiver products offer Automatic Gain Control (AGC) range, linearity, and integration for simplified receiver designs that require less tuning and higher line yields than discrete designs.

Set-top and Cable Modems

Our devices support the increasing requirements for today's set-top boxes. Skyworks' portfolio of Wi-Fi and LTE solutions enable multifunction set-top boxes and gateways supporting data-centric consumers. Solutions include 75 Ohm broadband LNAs and ultra-high linearity switches that feature ZigBee® RF4CE™ and Bluetooth® low energy connectivity.

New and Featured Products by Applications

The Right Design Choice Starts Here

We invite you to review our CATV product offerings from our broad portfolio. Full product specifications are available starting on page 8 in the order shown on the table below.

NEW products (purple, bold) are continually being introduced at Skyworks. For the latest information, please visit the New Products section of our website at www.skyworksinc.com.

Coming Soon products (blue, bold) indicates products that will be available soon for purchase.

Part Number	Description	Applications						
		DOCSIS 3.1 1.2 GHz HFC	Deep Fiber Mode + 0	1.0 GHz HFC	870 MHz HFC	Headend and Remote PHY	FTTx	Set-top and Cable Modem
Amplifiers								
SKY65452-92LF	40 MHz to 1 GHz Broadband 75 Ω CATV Low Noise Amplifier							
SKY65450-92LF	40 MHz to 1 GHz Broadband 75 Ω CATV Low Noise Amplifier with Bypass Mode							
ACA0861A, B, C, D	750 / 860 MHz CATV Line Amplifier MMIC							
ACA0862B, D	1 GHz CATV Line Amplifier MMIC							
ACA1205	750 / 870 MHz CATV Line Amplifier MMIC							
ACA1206	1 GHz CATV Line Amplifier MMIC							
ACA1212	1.2 GHz, 12 dB Gain, SOIC							
ACA1216	1.2 GHz, 27 dB Gain, Power Doubler SOIC							
ACA1240	1.2 GHz, 35 dB Gain, Edge QAM, MMIC							
ACA2402	750 / 870 / 1000 MHz CATV Push-pull Line Amplifier SOIC							
ACA2402E	750 / 870 MHz CATV Push-pull Line Amplifier SOIC							
ACA2407	750 / 870 / 1000 MHz CATV Power Doubler Line Amplifier SOIC							
ACA2407E	750 / 870 MHz CATV Power Doubler Line Amplifier SOIC							
ACA2420	1000 MHz High Output Power Doubler Line Amplifier SOIC							
ACA2429	1.2 GHz, 25 dB Gain, High Output Power, GaN, SOIC							
ACA2431	1.2 GHz, 28 dB Gain, High Output Power, GaN, SOIC							
ACA2460	1.2 GHz, 28 dB Gain, CATV Push-pull Driver Amplifier							
ACA2461	1.2 GHz, 25 dB Gain, CATV Push-pull Driver Amplifier							
ACA2778	1 GHz, 34.5 dB Gain, CATV Hybrid							
ACA2786	1 GHz, 25 dB Gain, CATV Hybrid							
ACA2788	1 GHz, 28 dB Gain, CATV Hybrid							
ACA3748	870 MHz, 25 dB Gain, CATV Hybrid							
ACA3754	870 MHz, 28 dB Gain, CATV Hybrid							
ACA4788	1.2 GHz, 23 dB Gain, High Output Power CATV Hybrid							
ACA4789	1.2 GHz, 25 dB Gain, High Output Power CATV Hybrid							
ABA3100	1 GHz, 12 dB Gain, Balanced Low Noise Amplifier							
ABA3101	1.2 GHz, 12 dB Gain, Balanced Low Noise Amplifier							
ADA10000	Single-ended Amplifier							
ADA10001	Single-ended Amplifier							
ADA1200	Single-ended Amplifier MMIC							
ARA05050	Reverse Amplifier with Step Attenuator							

Part Number	Description	Applications						
		DOCSIS 3.1 1.2 GHz HFC	Deep Fiber Node + 0	1.0 GHz HFC	870 MHz HFC	Headend and Remote PHY	FTTx	Set-top and Cable Modem
Amplifiers								
ARA2004	Reverse Amplifier with Step Attenuator							
	Programmable Gain Amplifier for DOCSIS 3.0 Upstream Path							
ACA2604	Fiber-to-the-Home RF Amplifier							
Diodes								
SMP1307 Series	Attenuator Series Pair SOT-23							
Front-end Modules								
SE5012T	5 GHz Front-end Module with Power Detector							
SE5516A	Dual Band 802.11a / g / n / ac Wireless LAN Front-end							
SE2438T	2.4 GHz Smart Energy / ZigBee® Front-end Module							
SE2431L	2.4 GHz ZigBee® / 802.15.4 Front-end Module							
SKY66109-11	2.4 GHz ZigBee® / Smart Energy Front-end Module							
SKY65366-11	400 MHz Transmit / Receive Front-end Module							
Mixers								
ACU2109	Wideband Tuner Upconverter							
Splitters								
APS3625	Five-way Active Power Splitter							
Switches								
SKY13548-385LF	5 to 1800 MHz Single Control SPDT 75 Ω Switch							
SKY13547-490LF	5 to 1800 MHz Ultra-high Linearity SPDT 75 Ω Switch							

Competitor Cross Reference

Skyworks Part Number Competitive Part Number

75 Ohm Gain Block Amplifiers for Hybrid Fiber Coaxial (HFC)

ABA3100	CGB-1089Z
ABA3101	RFCA8830
ADA10000	TAT7430B

12V Line Amplifiers for HFC

ACA0862D	TAT8804
ACA1206	RFCA8818
ACA1212	QPB8808
ACA1216	QPB8808
ACA1240	RFAM3620

Skyworks Part Number Competitive Part Number

24V Line Amplifiers for HFC

ACA2402	RFCM3080
ACA2460	RFCM4363
ACA2461	RFCM4363
ACA2407	RFCM2680
ACA2420	RFCM2680
ACA2429	RFCM3316
ACA2431	RFCM3326
ACA2778	S10040340
ACA3748	G8740250GTH
ACA3754	G8740270GTH
ACA2786	D10040250GTH
ACA2788	D10040270GTH
ACA4788	RFPD3580 or RFPD3570
ACA4789	RFPD3540

Skyworks Part Number Competitive Part Number

Upstream Amplifiers for HFC

ARA05050	TAT3814
ARA2017	TAT3814

FTTx/RFoG RF Amplifiers for HFC

ACA2604	TAT6254
---------	---------

SPDT (SP2T) RF Switches

SKY13547-490LF	RFSW1012
----------------	----------

Block Diagrams

Existing HFC System

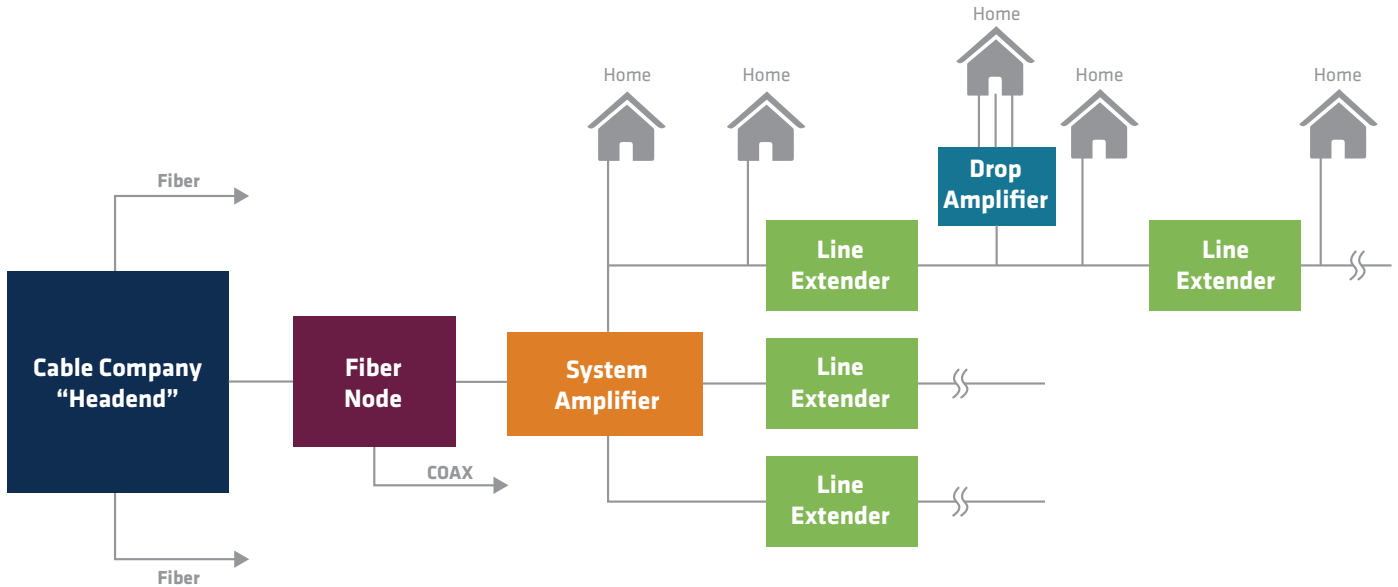

Headend: Optical Transmitter

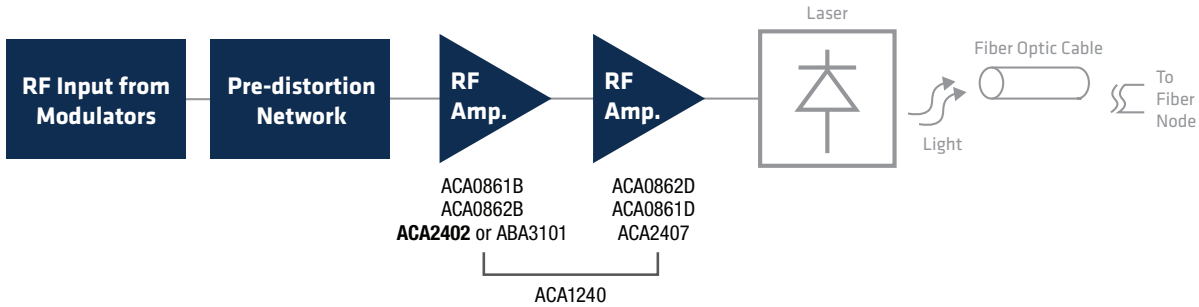

Typical Fiber Node (up to 5,000 Homes per Node)

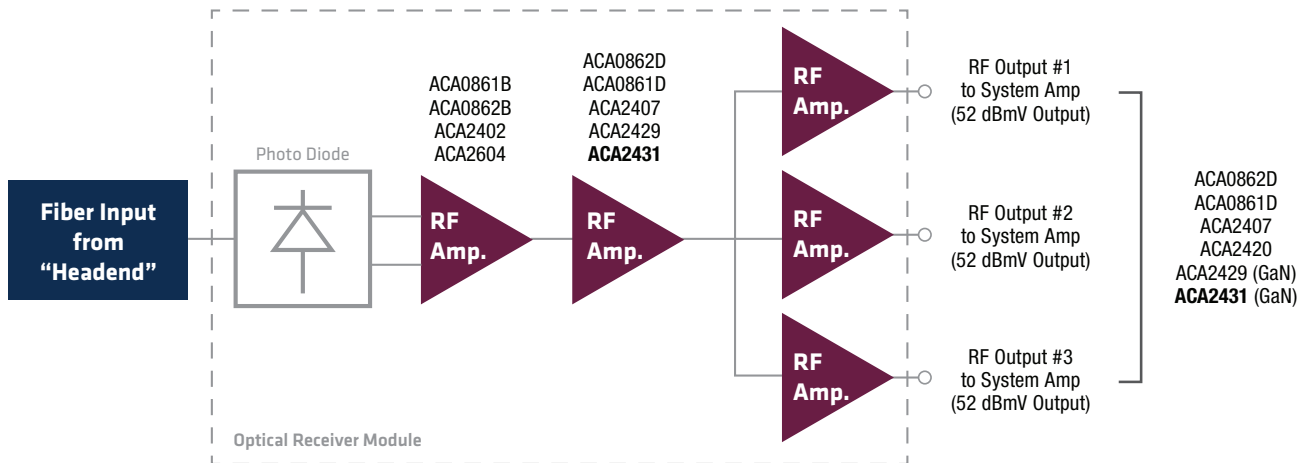

Deep Fiber Node (up to 200 Homes per Node)

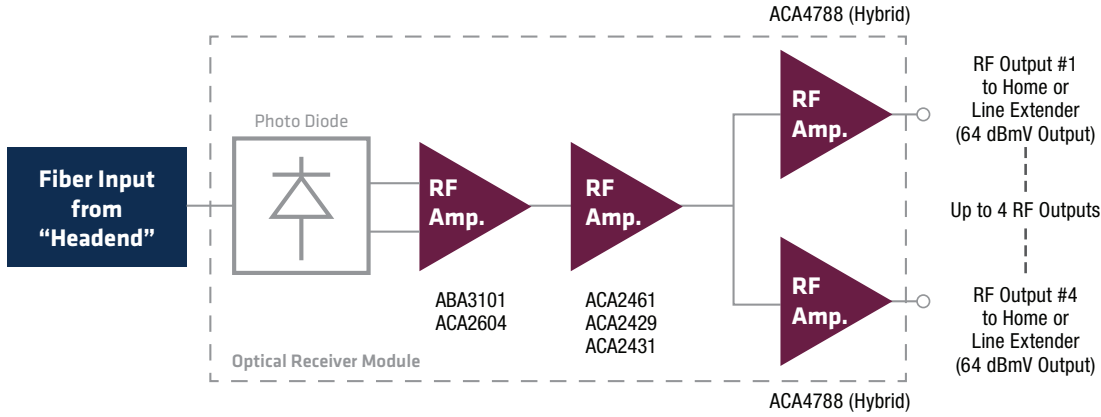

Typical System or Trunk Amplifier

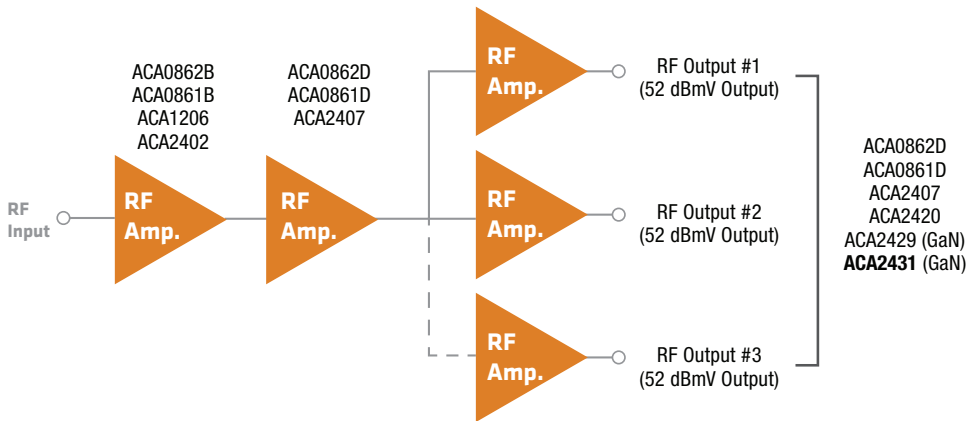

Typical Line Extenders

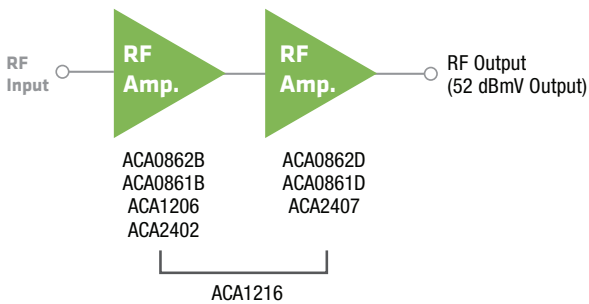

Drop Amplifier

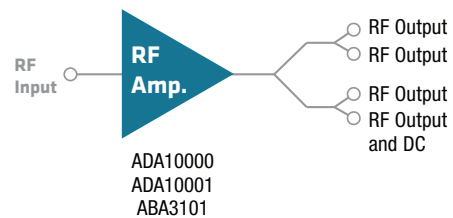



Product Specifications

Specification tables for products in this brochure are provided on the following pages. For a complete list of our newest products, please visit the New Products section of our website www.skyworksinc.com.

 Skyworks Green™ products are compliant to all applicable materials legislation and are halogen-free. For additional information, please refer to Skyworks Definition of Green™ document number SQ04-0074.











Amplifiers

Broad Market Low Noise Amplifiers





Part Number	Frequency (GHz)	Gain Typ. (dB)	OIP3 (dBm)	OP ₁ dB (dBm)	V _{DD} (V)	Supply Current Typ. (mA)	Noise Figure (dB)	Package (mm)
 SKY65452-92LF	0.04–1.0	15	28.4	–	–	42	2.9	6-pin SC-70 2.1 x 2.0 x 0.95
 SKY65450-92LF	0.04–1.0	15	28.4	–	–	42	2.9	6-pin SC-70 2.1 x 2.0 x 0.95

CATV Amplifiers

12V Line Amplifiers for Hybrid Fiber Coaxial (HFC)

Part Number	Frequency (GHz)	Min. Gain (dB)	Max. Gain (dB)	CTB Typ. (dBc)	CSO Typ. (dBc)	XMOD Typ. (dBc)	Supply Current Typ. (mA)	Noise Figure (dB)
 ACA0861A	0.75 / 0.86	11.4	12.4	-65	-70	-59	180	3
 ACA0861B	0.75 / 0.86	11.5	12.5	-62	-64	-55	310	3
 ACA0861C	0.75 / 0.86	11.5	12.5	-71	-73	-67	260	3
 ACA0861D	0.75 / 0.86	11.6	12.6	-67	-70	-66	450	3
 ACA0862B	1	10.7	11.7	-70	-68	-65	395	4
 ACA0862D	1	10.8	11.8	-76	-63	-74	530	4
 ACA1205	0.75 / 0.87	14.5	15.5	-65	-70	-59	180	2.5
 ACA1206	1	13.7	14.7	-74	-72	-70	195 @ R1 = 5.2 kΩ, 325 @ R1 = 2 kΩ	3
 ACA1212	1.2	10.5	11.7	-72	-70	-67	395	4
 ACA1216	1.2	26.5	28.5	-78	-70	-66	725	4
 ACA1240	0.45 – 1.218	35 (Typ.)		-65	-65	-60	480	4.5

24V Line Amplifiers for Hybrid Fiber Coaxial (HFC)

Part Number	Frequency (GHz)	Description	Min. Gain (dB)	Max. Gain (dB)	CTB Typ. (dBc)	CSO Typ. (dBc)	XMOD Typ. (dBc)	Supply Current Typ. (mA)	Noise Figure (dB)
 ACA2402	0.75 / 0.87 / 1	Push-pull Line Amplifier	21.1	22.1	-73	-72	-65	250	3.5
 ACA2402E	0.75 / 0.87	Push-pull Line Amplifier	21	22.5	-66	-62	-60	250	3.5
 ACA2407	0.75 / 0.87 / 1	Power Doubler Line Amplifier	20.8	22.1	-71	-66	-66	425	4
 ACA2407E	0.75 / 0.87	Power Doubler Line Amplifier	20.4	22.4	-65	-60	-60	425	4

Amplifiers

CATV Amplifiers (Continued)

24V Line Amplifiers for Hybrid Fiber Coaxial (HFC)

Part Number	Frequency (GHz)	Description	Min. Gain (dB)	Max. Gain (dB)	CTB Typ. (dBc)	CSO Typ. (dBc)	XMOD Typ. (dBc)	Supply Current Typ. (mA)	Noise Figure (dB)
ACA2420	1	24V, High Output, Power Doubler Line Amplifier	20.8	22.3	-78	-71	-64	520	6.5
ACA2429	1.218	High Output GaN, Power Doubler	24.5	26	-78	-66	-65	430	5
ACA2431	1.218	High Output GaN, Power Doubler Amplifier	27	28.5	-78	-66	-65	460	5
ACA2460	1.218	Push-pull Driver Amplifier	27.5	28.5	-68	-67	-60	290	–
ACA2461	1.218	Push-pull Driver Amplifier	25.9	27.5	-68	-67	-60	290	5
ACA2778	1	Power Doubler Amplifier	34	36	-68	-68	-60	290	5
ACA2786	1	Power Doubler Hybrid Amplifier	24	26	-70	-70	-63	430	7.5
ACA2788	1	Power Doubler Amplifier	27	29	-70	-70	-63	430	3.5
ACA3748	0.87	Power Doubler Amplifier	24	26	-65	-65	-59	430	5
ACA3754	0.87	Power Doubler Amplifier	27	29	-65	-65	-59	430	3.5
ACA4788	1.2	Power Doubler Amplifier	–	–	-76	-80	-70	765	4
ACA4789	1.2	Power Doubler Amplifier	–	–	-70	-68	-65	410	4

75 Ohm Gain Block Amplifiers for Hybrid Fiber Coaxial (HFC)

Part Number	Description	Typ. Gain (dB)	CTB Typ. (dBc)	CSO Typ. (dBc)	Supply Current Typ. (mA)	Supply Voltage (Vdc)	Noise Figure (dB)
ABA3100	Balanced Low Noise Amplifier	12	-75	-72	150	5	2.5
ABA3101	Balanced Low Noise Amplifier	12.5	-72	-70	212	8	2.5
ADA10000	Single-ended Amplifier	15	–	–	–	8	2
ADA10001	Single-ended Amplifier	15	–	–	–	8	2
ADA1200	Single-ended Amplifier	12	-75	57 (Channels 5 and 6) -59 (all other channels)	80	5	2.3

Upstream Amplifiers for Hybrid Fiber Coaxial (HFC)

Part Number	Description	Typ. Attenuator Step Size (dB)	Typ. Attenuation Range (dB)	Frequency (MHz)	Output Power (dBmV)	Typ. Gain (dB)	Typ. Noise Figure (dB)
ARA2004	Reverse Amplifier with Step Attenuator	1	0 to 59	5–100	60	29.3	3
ARA2017	Address-programmable Reverse Amplifier with Step Attenuator	1	0 to 58	5–85	64	36	2.5
ARA05050	Reverse Amplifier with Step Attenuator	2	0 to 30	5–100	58	32	1.7

FTTx/RFoG RF Amplifiers for Hybrid Fiber Coaxial (HFC)

Part Number	Description	Equivalent Input Noise (pA/rHz)	Typ. Gain (dB)	Gain Adjust Range (dB)	Typ. CTB (dBc)	Typ. CSO (dBc)	Input Impedance (Ohms)
ACA2604	Fiber-to-the-Home RF Amplifier	4.5	24	22	-65	-65	400

Diodes

Attenuator PIN Diode

Plastic Surface Mount (SMT) Attenuator PIN Diode

Part Number	Min. V_B $I_R = 10 \text{ A}$ (V)	Max. C_T $V_R = 30 \text{ V}$ (pF)	Typ. V_F $I_F = 10 \text{ mA}$ (V)	Typ. R_S $I_F = 1 \text{ mA}$ F = 100 MHz (Ohms)	Max. R_S $I_F = 10 \text{ mA}$ F = 100 MHz (Ohms)	R_S $I_F = 100 \text{ mA}$ F = 100 MHz (Ohms)	Typical Carrier Lifetime $I_F = 10 \text{ mA}$ (ns)
 SMP1307 Series	200	0.30	0.85	100	15	3.0	1500

Front-end Modules

Wi-Fi Connectivity





5 GHz Front-end Module

Part Number	Frequency (GHz)	802.11 WLAN Standard	Antenna Ports	Architecture	Typ. Current @ $V_{CC} = 3.3 \text{ V}$ (mA)	Typ. P_{OUT} @ 3% EVM (dBm)	Typ. Tx Gain (dB)	V_{CC} (V)	Package (mm)
 SE5012T	4.9–5.85	a	1	5 GHz Front-end Module with Power Detector	–	17 21	–	3.3 5	16-pin QFN 3 x 3 x 0.6

Dual-band Front-end Module

Part Number	Frequency (GHz)	802.11 WLAN Standard	Antenna Ports	Architecture	Typ. Current @ $V_{CC} = 3.3 \text{ V}$ (mA)	Typ. P_{OUT} @ 3% EVM (dBm)	Typ. Tx Gain (dB)	Package (mm)
 SE5516A	2.4–2.5 4.9–5.9	a b g n (2G) n (5G) ac (2G) ac (5G)	1	Wireless LAN Front-end	220 205 185 – – 155 190	16 21 18 18 (@ 3.0% EVM) 16 (@ 3.0% EVM) 16 (@ 1.8% EVM) 13 (@ 1.8% EVM)	25–30	24-pin LGA 4 x 4 x 1.0

Smart Energy–Connected Home and Automation 802.15.4, ISM and ZigBee®

Part Number	RF Frequency (MHz)	Typ. Rx Insertion Loss (dB)	Typ. Rx Gain (dB)	Typ. Rx NF (dB)	Tx Gain (dB)	Typ. Saturated Output Power (dBm)	Supply Voltage (V)	Package (mm)
 SE2431L	2400–2483	2	12.5	2	23	24	2.0–3.6	24-pin QFN 3 x 4 x 0.9
 SE2438T	2400–2500	3.5	12.3	2.7	16	16	2.0–3.6	20-pin QFN 3 x 3 x 0.55
 SKY66109-11	2400–2483	–	11.5	2	22	21	2.0–3.6	20-pin MCM 3 x 4 x 0.9
 SKY65366-11	400–500	0.4	21	1.8	22	30.2	2.0–3.6	28-pin MCM 6 x 6 x 1.05

Mixers

Upconverter for Set-top Box Applications

Part Number	Description	RF Frequency (MHz)	IF Frequency (MHz)	Typ. Phase Noise @ 10 kHz Offset (dBc/Hz)	Max. Phase Noise @ 10 kHz Offset (dBc/Hz)	Typ. Conversion Gain (dB)	Typ. Noise Figure (dB)	Typ. Power Consumption (mW)
ACU2109	Wideband Tuner Upconverter	50 to 860	900 to 1200	-89	-84	8	6.5	770

Splitters

Active Splitters for Set-top Box Applications

Part Number	Description	Typ. Gain (dB)	Typ. Noise Figure (dB)	Typ. CTB (dBc)	Typ. CSO (dBc)	Typ. XMOD (dBc)	Typ. Current Consumption (mA)	Package (mm)
APS3625	Five-way Active Power Splitter	4	4.8	-70	-60	-67	130	24-pin QFN 4 x 4 x 0.9

Switches

SPDT (SP2T) RF Switches

Part Number	Description (Absorptive/ Reflective)	Frequency (GHz)	Typ. IL (dB)	Typ. Isol. (dB)	Typ. IIP3 (dBm)	Typ. IP _{1dB} (dBm)	Package (mm)
SKY13547-490LF	SPDT (R)	0.005–1.8	0.2–0.35	50	–	85	12-pin QFN 2 x 2 x 0.55
SKY13548-385LF	SPDT (R)	0.005–1.8	0.4	27	57	33	6-pin QFN 1 x 1 x 0.45

For more information, please visit us at www.skyworksinc.com.





Skyworks Sales Offices

USA

Headquarters: Massachusetts

Skyworks Solutions
20 Sylvan Road
Woburn, MA 01801
Telephone: (781) 376-3000
Fax: (781) 376-3100
sales@skyworksinc.com

California

Skyworks Solutions
5221 California Avenue
Irvine, CA 92617
Telephone: (949) 231-3000
Fax: (949) 231-3206
sales@skyworksinc.com

Skyworks Solutions
2740 Zanker Road
San Jose, CA 95134
Telephone: (408) 232-2900
Fax: (408) 232-2902
sales@skyworksinc.com

Maryland

Skyworks Solutions
5520 Adamstown Road
Adamstown, MD 21710
Telephone: (301) 695-9400
Fax: (301) 695-7065
transtech@skyworksinc.com

EUROPE

France

Skyworks Solutions
60 rue Saint André des Arts
Bâtiment D
75006 Paris
France
Telephone: +33 1 43548540
Fax: +33 1 43540005
irene.pfeiffer@skyworksinc.com

United Kingdom

Skyworks Solutions
Ground Floor, Riverside House
Riverside
Bishop's Stortford
Herts CM23 3AJ
United Kingdom
Telephone: +44 7920 838883
will.kerley@skyworksinc.com

Finland

Skyworks Solutions
Keilaranta 16 (5th Floor)
FIN-02150 Espoo
Finland
Telephone: +358 9251 07131
Fax: +358 9 2510 7129
tommi.hiillos@skyworksinc.com

ASIA • PACIFIC

China

Skyworks Solutions
Unit 1201-1203 and 1206, Bldg# A,
No. 868 Yinghua Road
Pudong, Shanghai, China, PRC
Telephone: +86 21 23066230
ext. 60167
Fax: +86 21 33663398
elaine.zhao@skyworksinc.com

Skyworks Solutions
Room 2701, 27/F Tower 3
Kerry Plaza
No. 1 Zhongxinsi Road
Futian District
Shenzhen 518048 China PRC
Telephone: +86 755 8828 8399
Fax: +86 755 8828 8358
jesse.li@skyworksinc.com

Skyworks Solutions
Suite 1315, Tower B, COFCO Plaza, No. 8
Jianguomennei Avenue
Dongcheng District
Beijing 100005 China PRC
Telephone: +8610 652 60859
ext. 61602
Fax: +8610 652 61358
abby.huang@skyworksinc.com

Japan

Skyworks Solutions
Tokyo Opera City Tower 36F
3-20-2 Nishi-Shinjuku
Shinjuku-ku
Tokyo, 163-1436
Japan
Telephone: +81 3 5308 5180
Fax: +81 3 5308 5190
ahihiro.karikomi@skyworksinc.com

Korea

Skyworks Solutions
POSCO Center (West Wing 12F)
440 Taeheran-ro, Gangnam-ku
Seoul, 06194, Korea
Telephone: +82 2 3490 3800
Fax: +82 2 553 5459
juhee.lee@skyworksinc.com

Singapore

Skyworks Solutions
10 Ang Mo Kio Street 65
#05-15/16 Techpoint
Singapore 569059
Telephone: +65 64031971
Fax: +65 64031931
yuenfong.choong@skyworksinc.com

Taiwan

Skyworks Solutions
4 F, #198, Section 2
Tun Hwa S. Road
Taipei 106, Taiwan ROC
Telephone: +8862 5559 8992
Fax: +8662 2735 6508
joanna.wu@skyworksinc.com

Skyworks Solutions, Inc. | NASDAQ: SWKS | sales@skyworksinc.com

USA: 781-376-3000 | Asia: 886-2-2735 0399 | Europe: 33 (0)1 43548540 | BRO420-17A 5/17 |

